



Step inside a Signature Home Lift

A discreet and practical alternative to using the stairs

stairCare
lifting the quality of life



What won us over to a Duo+ HomeLift was its beautiful, compact design - light years away from unsightly stair lifts

Mr. & Mrs. Hamilton, Oxfordshire

The Signature HomeLift range. Specially designed to fit easily into your home.

Already popular around the world with many hundreds of satisfied customers, the Signature HomeLift was the first of its kind in the UK.

Designed to make your life easier, a Signature HomeLift allows you to travel safely and effortlessly between floors, its unique rail and drive system allows you to fit the lift almost anywhere in the home.

Taking up minimal space, and with the smallest footprint, the Duo range gives you flexibility in where to fit your lift, whilst maximising your living space. The Trio range gives you the convenience of a larger lift car size if you need to travel in a wheelchair - either now or in the future.

Committed to accessible living, the unique Signature HomeLift range allows you to remain living independently in your home. For complete peace of mind a comprehensive 12 month parts and labour warranty is provided with all new installations.

So, if you're looking for an innovative, attractive and useful long-term accessible living solution, the answer has to be a Signature HomeLift.



A Compact and Luxurious HomeLift

The Signature through-floor HomeLift is designed to make it easier for you to move around the house. Whether you're starting to find the stairs a bit much, or are planning ahead by future-proofing, you will find a Duo will fit discreetly into any home.

A Duo+ is elegantly curved and with its clear car body, it will perfectly compliment your style of décor. It's so versatile that it can be installed in the corner of a room, in a cupboard or in a stairwell void. Alternatively it can take pride of place in the centre of a room or entrance hallway.

We all need to do our bit for the environment, and a Signature HomeLift is no different. Each one of our models plugs into a standard mains socket and uses no more electricity than switching your toaster on!

Installation is simple – in most cases work is completed within a single day and once your HomeLift is fully working, our friendly installation engineers will guide you through the simple usage instructions.

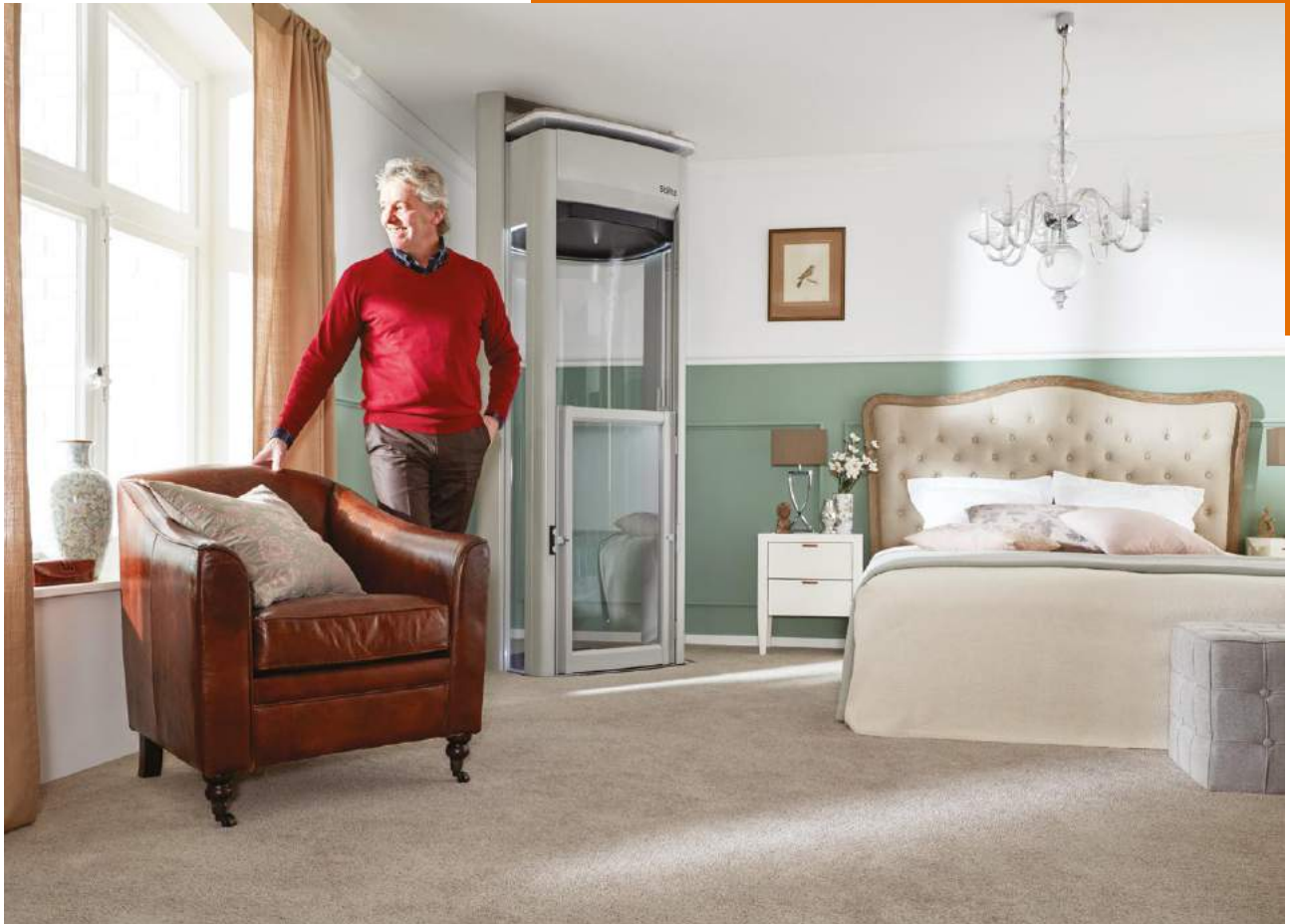



Trio+ Spacious Luxury HomeLift

The Signature Trio is a larger HomeLift designed to comfortably carry a full-sized wheelchair, or three people. The HomeLift's clear body helps it blend seamlessly into your home and the unique shape means the rails are discreetly recessed behind the slightly wider entrance/exit.





The Signature Trio has been designed to offer more space and luxury for homeowners who need a larger lift for their home.

The combination of style and practicality has been perfectly balanced with the Trio+. Due to its size and weight loading, the HomeLift can comfortably accommodate a full-sized wheelchair as well as carrying an extra person. The gently-angled integral ramp and the wider entrance/exit space, helps make access very simple.

Just like the Duo+ though, the Trio+ HomeLift will install quickly without any need for load-bearing walls, travel quietly and use minimal power when moving between floors.

Why Choose a Signature HomeLift?



Maximise your living space

Move your lift to the another floor and with only two slim rails remaining, you'll hardly know it is there.



Small footprints

Both the Duo+ and the Trio+ have extremely compact footprints, despite the fact that the Trio+ will accommodate a full-sized wheelchair.



Elegant interior lighting

Subtle and attractive internal lighting at the top and bottom of the lift car means you can travel in safety any time during the day or night.



Packed with safety features

Multiple sensors are fitted to every Stiltz HomeLift to ensure that everyone remains safe – both inside and outside the lift.



In-car control panel

The in-car control panel is designed to be extremely easy to use with push-button, hold-to-run controls.



Remote control

Your HomeLift comes with two remote control handsets included. Additional handsets can be purchased if required.

Signature HomeLifts Features & Benefits



Small Footprint

The Duo+ footprint is a remarkably small 0.8m². The slightly larger Trio+ footprint will accommodate a full-sized wheelchair, and has a footprint of 1.44m².



Quiet

Powered by a self-contained, electric drive motor which is completely hidden away in the lift car roofspace. There are no noisy hydraulics with a Signature HomeLift.



Fast Installation

Standard installations can take as little as one day once the ceiling aperture has been created by a qualified builder.



Power Consumption

A Signature HomeLift plugs into a single, standard 13 amp domestic power socket - just like any other domestic appliance. When running, it uses no more power than if you were to switch your toaster on.



Unique Guide System

It's what makes a Signature HomeLift so wonderfully versatile; our self-supporting structure of two parallel, vertical rails bear the entire load of the lift. No additional burden is placed on the structure of your home.



Self Contained Drive System

Our unique, self-contained drive system is cleverly concealed in a single space within the roof area of the lift car. No need for additional bulky plant rooms or other machinery.



Fire Seal

The Trio+ has undergone extensive fire seal testing and fully complies with BS5900:2012 Powered HomeLifts plus has full BS EN 81-41 accreditation.



Automatic Door

To make entry and exit more straightforward for wheelchair users or customers with limited mobility, the Trio+ has an automatic door available as an optional extra.



Wide Entry

Wheelchair users will find the wide entry and exit points of the new Trio+ particularly useful when manoeuvring their chair in confined spaces.



Level Access

For safety and comfort, the Trio+ comes with a gently-angled ramp to enable more convenient entry for wheelchair users and those unable to manage steps.

Typical Lift Installation Applications

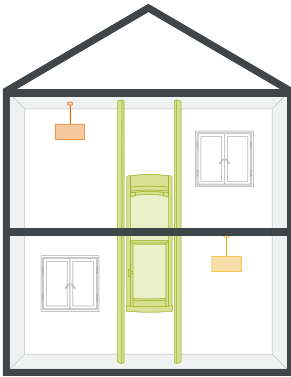

Standard

This is our most popular configuration, the HomeLift will travel between a downstairs room such as living room and arrive upstairs, typically in a bedroom.

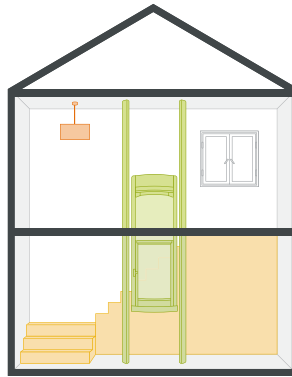

Stairwell void/landing

Where there is enough room in the turn of a staircase, this positioning option makes use of the dead space in the void making the HomeLift even more unobtrusive.



Cupboard

Thanks to the compact nature of a Stiltz HomeLift, you can choose to have your lift completely hidden by installing it inside an airing cupboard or wardrobe.

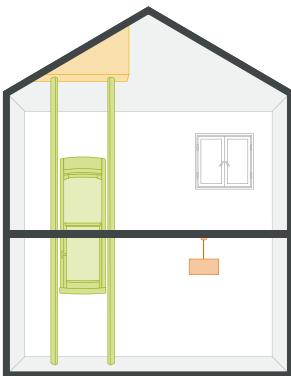

Sloping/vaulted ceilings

Our vertical rails need to fix to a horizontal surface. But don't worry if you have a vaulted ceiling. Our building teams can provide subtle solutions to overcoming pitched roof installations.

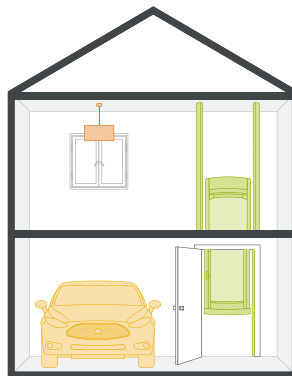

Garage

If you are looking to get from your garage safely into your home we can build a simple shaft around your Stiltz HomeLift to take into account health and safety considerations.

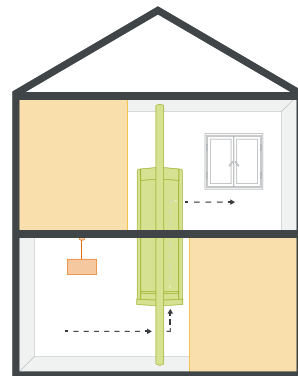

Thru-Car

Unique to Stiltz HomeLifts is the Thru-Car concept. Enter and exit through opposite sides of the lift car - ideal for wheelchair users or for lifts built into a stairwell void.

Lift Footprints

Duo+ Footprint

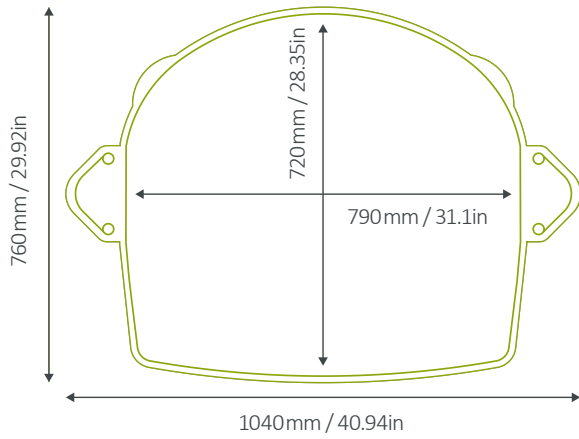

Trio+ Footprint

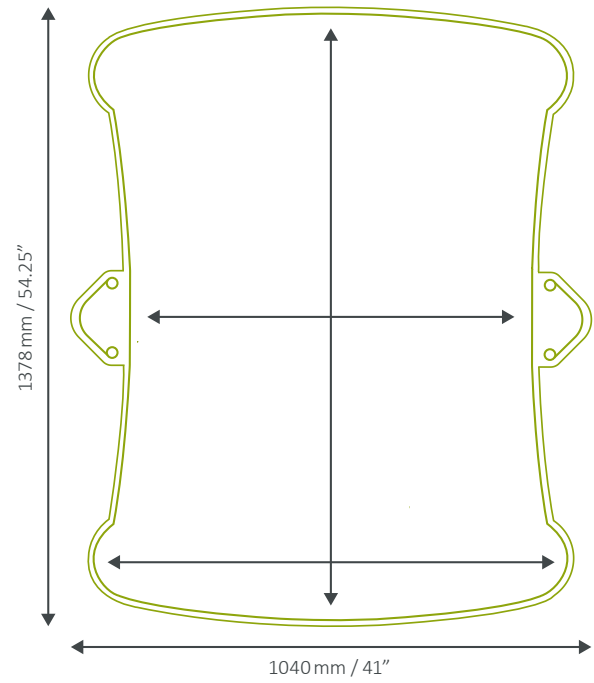



FAQs

Is a Signature HomeLift suitable for wheelchair users

Yes. The Stiltz Trio+ HomeLift is ideal for homeowners with mobility issues as it allows them the freedom and independence to move around the home unhindered.

The Trio+ is our widest and deepest model in our Signature range and can accommodate a manual wheelchair. It is an ideal alternative to a stairlift and perfect if you have limited mobility.

Can I stay in my home for longer with a Signature HomeLift?

Yes. A Signature HomeLift is a great help to those with mobility problems, but it is also purchased by those who are able bodied and looking to future proof their homes. This means you can have the peace of mind to continue to live a full life in the family home you love for many years to come.

What happens if the power fails and I am in my Signature HomeLift?

In the event of a power cut to the home all Signature HomeLifts are equipped with a battery back-up facility. This is included as standard with the lift and will allow anyone in the lift at the time of power failure to gently descend to the lower level of the home, exit the lift, and wait until the power comes back on.

We also offer the option of an uninterrupted power supply. This system can be installed at an extra cost but will allow for numerous trips both up and down while the main power to the lift is out.

Does the Signature HomeLift have a door?

Signature HomeLifts are fitted with a self-closing, hinged door (doors comes in both half height and full height options) that provides a physical barrier during the operation of the lift. The door locks will release when the lift arrives safely at the floor of choice.

Can I customise my Signature HomeLift?

Yes. Each Signature HomeLift can be tailored to your specific taste. The carpet, rail and lift car colours can all be changed to suit your home. Signature also offers a range of different seats and handrails.

What building work will need to be carried out?

Unlike conventional lifts, all that a Signature HomeLift requires for installation is the appropriate aperture to be cut out and trimmed by a qualified builder. The work itself is minimal and not time consuming. There may be instances where small amounts of additional work may need to be carried out such as moving pipes but these will be managed by our building teams and our surveyor will discuss this with you.

How safe is the Signature HomeLift?

The Signature HomeLift has safety sensors fitted above and below the lift car which detect obstructions and smoothly stop the car. The lift is also fitted with a full height light curtain which acts as a sensor and ensures nothing crosses into or out of the lift as it travels. Signature engineers are on call 24/7 in the event of a lift emergency.

Is VAT applicable on a Signature HomeLift?

VAT is chargeable on all Signature HomeLifts but if you are disabled or have a long-term illness you may be exempt from paying VAT on products designed or adapted for your own personal or domestic use. If you think you may qualify for VAT relief, please request an exemption form from a member of the Staircare sales team.

Am I able to receive a Disabled Facilities Grant for a Signature HomeLift?

You may be eligible for a Disabled Facilities Grant if you are disabled and need to make changes (including the installation of a domestic lift) to your home which would improve access to rooms and facilities. A Disabled Facilities Grant will not affect any benefit payments you receive.



We needed our home to be accessible, but at the same time we didn't want to compromise the style of our Cotswolds period property. A Stiltz HomeLift has fully met our needs on both counts

Mr. & Mrs. Randall, Gloucestershire